



HAMILTON-C1

Quick Guide

This Quick Guide is intended as a useful reference for ventilation of **adult and pediatric** patients. It does *not* replace the clinical judgment of a physician nor the content of the ventilator *Operator's Manual*, which should always be available when using the ventilator.

Some functions are optional and are *not* available in all markets.

The graphics shown in this guide may *not* exactly match what you see in your environment.



HAMILTON-C1 v3.0.x
2020-09-15

Table of contents

1. HAMILTON-C1 basics.....	4
2. Navigation shortcuts and icon states.....	10
3. Setting up the ventilator.....	11
4. Configuring patient settings.....	21
5. Performing the preoperational check.....	22
6. Configuring ventilation settings.....	26
7. CPR ventilation.....	30
8. Monitoring the patient.....	31
9. Working with a connected HAMILTON-H900 humidifier.....	35
10. Connectivity: Bluetooth, Wi-Fi, Wi-Fi Access Point.....	36
11. Ventilation modes.....	38
12. Monitoring parameters (ventilator).....	40
13. Control settings.....	44

1. HAMILTON-C1 basics

1.1 Ventilator, front view

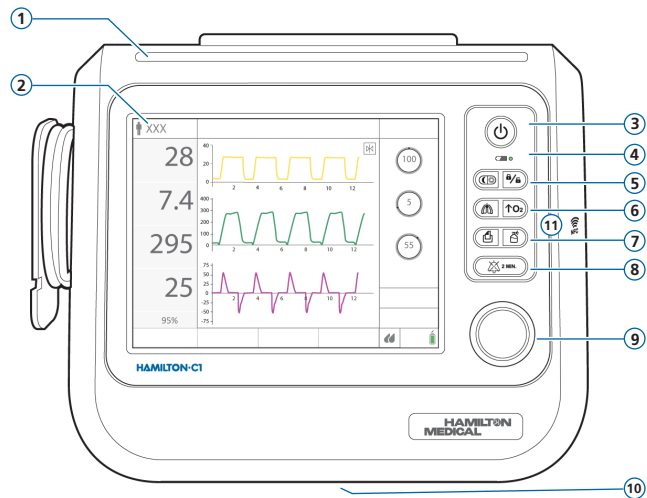

- 1 Alarm lamp.** Lit when an alarm is active. Red = high priority. Yellow = medium or low priority.
- 2 Touch screen display**
- 3 Power/Standby key.** Turns the ventilator on/off; used to enter Standby.
- 4 Battery charge indicator.** Lit = Fully charged. Flashing = Charging. Dark = In use.
- 5 Day/Night key.** Switches between Day and Night display brightness setting.
- 6 Screen lock/unlock key.** Disables/enables the touch screen (for example, for cleaning).
- 7 Manual breath key.** Delivers a mandatory breath or a prolonged inspiration.
- 8 O2 enrichment key.** Delivers a maximum of 100% oxygen for a set time. Also used for suctioning.
- 9 Print screen key.** Saves a screenshot of the current display to a USB drive or internal memory.
- 10 Nebulizer key.** Activates the pneumatic nebulizer for 30 minutes. Press the key again to turn nebulization off.
- 11 Audio pause key.** Pauses the audible alarm for 2 minutes. Press the key again to cancel the Audio pause.
- 9 Press-and-turn (P&T) knob.** Used to select and adjust settings.
- 10 Expiratory valve bleed port.** (on bottom of ventilator) *Do not obstruct.*
- 11 Near-field communication (NFC) connection area**

1. HAMILTON-C1 basics

1.2 Ventilator, side view with gas connections

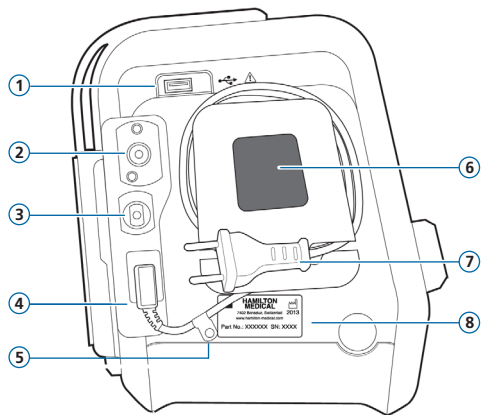

- 1 USB port
- 2 High-pressure oxygen DISS or NIST inlet fitting
- 3 Low-pressure oxygen fitting
- 4 Power socket
- 5 AC power cord retaining clip
- 6 Cooling air intake and dust filter
- 7 AC power cord
- 8 Serial number label

1. HAMILTON-C1 basics

1.3 Ventilator, side view with breathing circuit connections

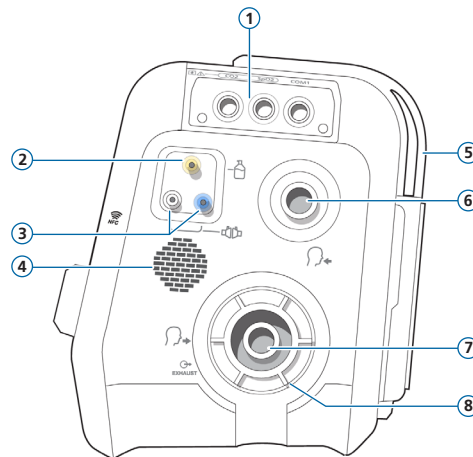

- 1 Communication board (optional)
- 2 Pneumatic nebulizer port
- 3 Flow sensor connection ports
- 4 Loudspeaker
- 5 Cooling air outlet
- 6 *To patient* inspiratory port
- 7 *From patient* expiratory port
- 8 Expiratory valve set

1. HAMILTON-C1 basics



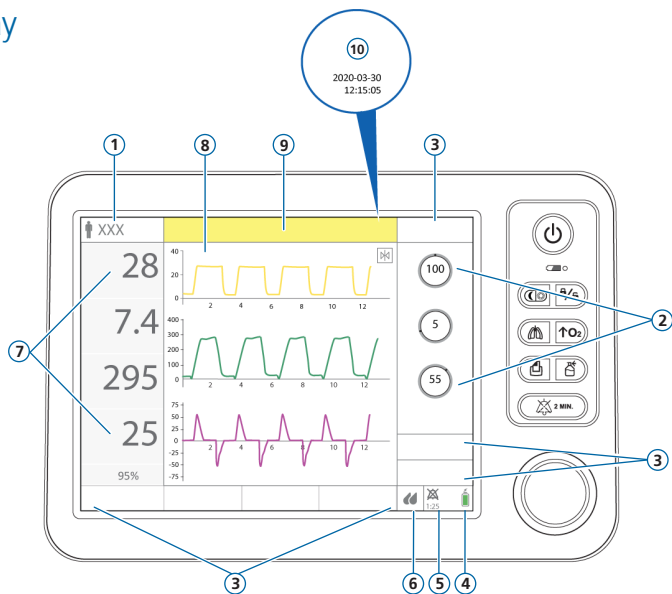

1.4 Main display



- 1 Active mode and patient group.** Shows the active mode and selected patient group.
- 2 Controls.** Quick access to key control settings for the active mode.
- 3 Window buttons.** Open the Modes, Monitoring, Tools, Events, System, Alarms, Controls windows. The Controls window provides access to Patient, SpeakValve, and Apnea settings.
- 4 Power source.** Shows the active and available power sources.
- 5 Audio pause indicator/connectivity icons.** Shows that Audio pause is enabled and how much time remains before the audible alarm sounds. This area also shows the connectivity icons; see page 10.
- 6 Humidifier quick access icon.** Touch to access the Humidifier* window.
- 7 Main monitoring parameters (MMPs).** Configurable monitoring data and current monitored SpO2 value**.
- 8 Graphic panels.** Can display a combination of selectable real-time waveforms, loops, trends, and Intelligent panels.
- 9 Message bar.** Displays alarms and other messages.
- 10 Date/Time.** Shows the current date and time. This area also shows the i-icon; see page 34.

* If HAMILTON-H900 humidifier is connected to the communication board. ** If SpO2 monitoring is installed and enabled.

2. Navigation shortcuts and icon states

Touch ...	To display ...	Touch ...	To display ...
	Controls > Patient window	2017-08-07 07:11:58	System > Settings > Date & Time window
Active mode (top left of display)	Modes window If in INTELLiVENT-ASV mode*, displays the Settings window.	 or 1:40	Alarms > Buffer window
Any MMP	Alarms > Limits 1 window	Alarm message in the Alarms > Buffer window	On-screen alarm troubleshooting help
SpO2 value (under MMPs)	Alarms > Limits 2 window		System > Settings > Humidifier window**
Any graphic (wave- form, loop, trend, Intelligent panel)	Graphics selection window		System > Settings > Connectivity window
 (any displayed battery icon)	System > Info window	(any displayed connectivity icon*)	When an Audio pause is active, the connectivity icons are not displayed.

* If the option is installed. Not available in all markets.

** If connected to the COM1 port on the ventilator.

3. Setting up the ventilator

3.1 Installing the expiratory valve set

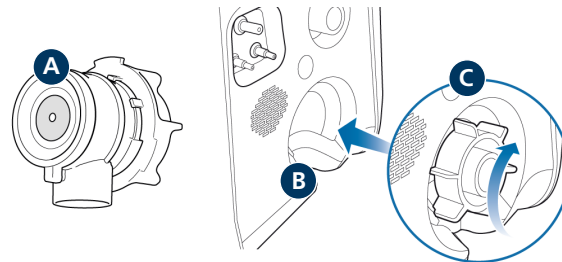

To install the expiratory valve set

- 1 Remove the safety cover.
- 2 Ensure the membrane is properly aligned with the expiratory valve housing, and the metal plate faces up (A).
- 3 Position the expiratory valve set in the expiratory port (B) and twist the locking ring clockwise until it locks into place (C).

3. Setting up the ventilator

3.2 Connecting a humidifier (optional for integration)

Back/bottom of
HAMILTON-H900 humidifier

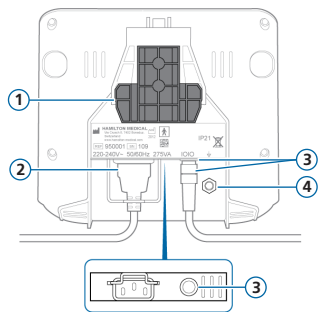

☁/COM1 port on ventilator

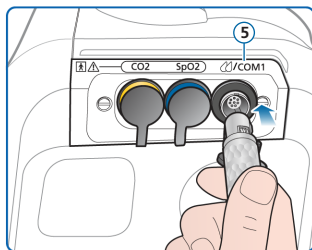

- 1 Mounting bracket
- 2 HAMILTON-H900 power cord
- 3 COM port and communication cable; connects to the ventilator ☁/COM1 port (5)
- 4 Potential equalization conductor
- 5 ☁/COM1 port on ventilator

If connecting a HAMILTON-H900 humidifier to the ☁/COM1 port, operation of the humidifier is integrated with the ventilator; see page 35.*

You can also use the humidifier without integration by simply connecting it to the breathing circuit.

* Not available in all markets.

3. Setting up the ventilator

3.3 Connecting a breathing circuit (humidification/HMEF)

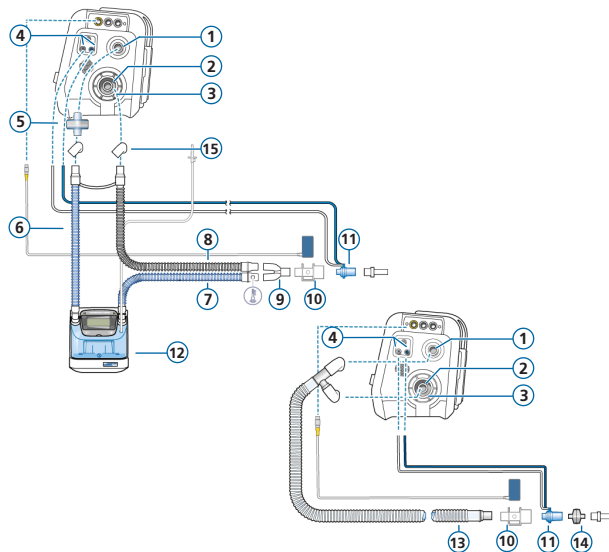

- 1 To patient inspiratory port
- 2 From patient expiratory port
- 3 Expiratory valve set
- 4 Flow sensor connection ports
- 5 Bacterial/viral filters
- 6 Inspiratory limb to humidifier
- 7 Heated inspiratory limb with temperature sensor, to patient
- 8 Heated expiratory limb
- 9 Y-piece
- 10 CO2 sensor/adaptor
- 11 Flow sensor
- 12 Humidifier
- 13 Coaxial inspiratory/expiratory limb
- 14 HMEF
- 15 Adapters

3. Setting up the ventilator

3.4 Connecting a breathing circuit (High flow oxygen)

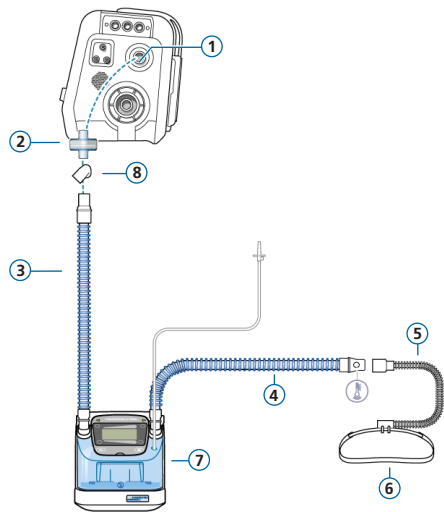

- 1 To patient inspiratory port
- 2 Bacterial/viral filter
- 3 Inspiratory limb to humidifier
- 4 Heated inspiratory limb with temperature sensor, to patient
- 5 Nasal cannula
- 6 Attachment strap
- 7 Humidifier
- 8 Adapters (various)

High flow oxygen is not available in all markets.

3. Setting up the ventilator

3.5 Connecting a nebulizer (optional)

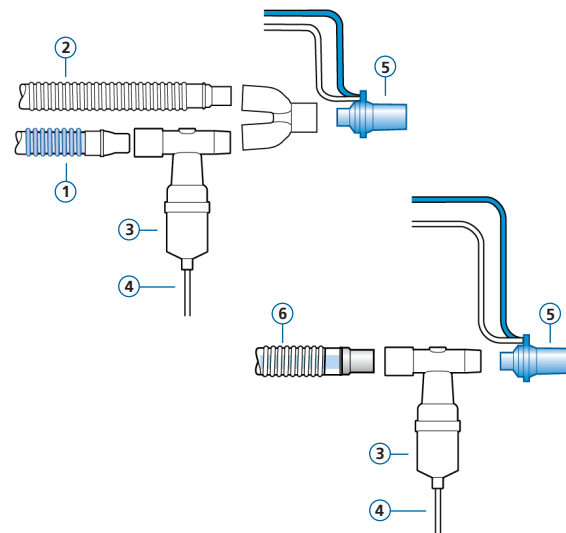

- 1 Inspiratory limb
- 2 Expiratory limb
- 3 Nebulizer (example)*
- 4 Connection tube to ventilator
- 5 Flow sensor
- 6 Coaxial breathing circuit

For additional placement options, including with the use of an Aerogen nebulizer, see the *Nebulizer Positioning Guidelines* (ELO2020-124-TW), available on MyHamilton.

*Place the nebulizer according to your institution's protocol.

3. Setting up the ventilator

3.6 Connecting a mainstream CO2 sensor

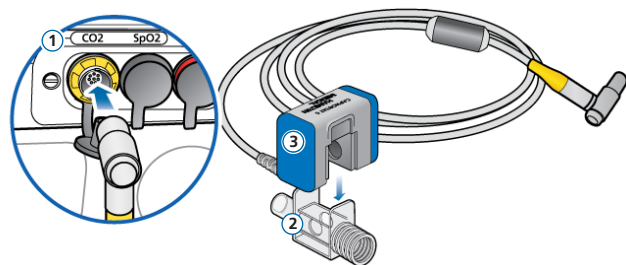

Attaching the CO2 sensor to the airway adapter

- 1 Connect to CO2 port on the ventilator
- 2 Airway adapter
- 3 CO2 sensor

Connecting the CO2 sensor/adapter* to the breathing circuit

- ▶ See the diagram to the left.

*Connect the CO2 sensor in front of or behind the flow sensor, according to your institution's protocol.

3. Setting up the ventilator

3.7 Connecting an SpO2 pulse oximeter (Masimo SET)

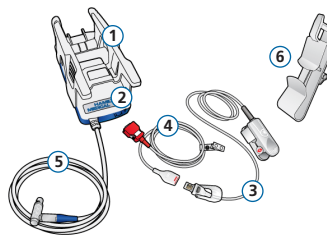

Masimo SET pulse oximeter components*

- 1 Adapter containing the oximeter hardware
- 2 Cable connection ports
- 3 RD Series sensor and cable
- 4 Patient cable (connects to adapter and sensor)
- 5 Adapter cable (connects the adapter to the SpO2 port on the ventilator communication board)
- 6 Sensor cable holder

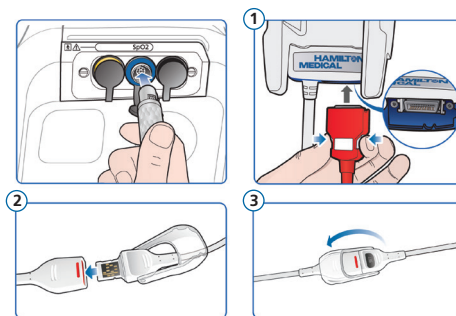

To connect the cables*

- ▶ Connect the patient and sensor cables to the ventilator as shown.

* Your cables may look different from those shown.

3. Setting up the ventilator

3.8 Connecting an SpO2 pulse oximeter (Nihon Kohden)

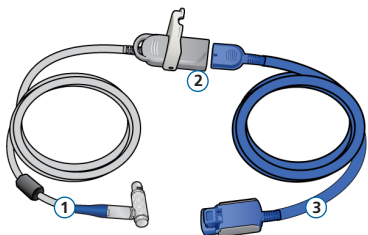

Nihon Kohden pulse oximeter components

- 1 Adapter cable (connects the adapter to the SpO2 port on the ventilator)
- 2 Adapter
- 3 Sensor and sensor cable

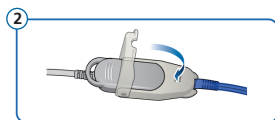
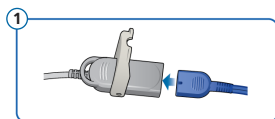
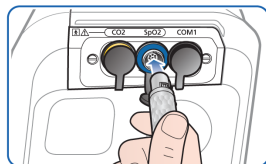

To connect the cables

- ▶ Connect the patient and sensor cables to the ventilator as shown.

3. Setting up the ventilator

3.9 Turning on the ventilator

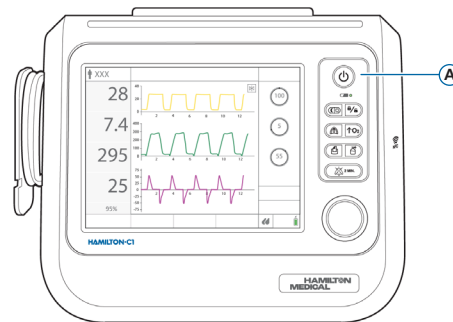

To turn on the ventilator

- 1 Connect the ventilator to AC power and oxygen supply.
- 2 Assemble and connect the patient breathing circuit.
- 3 Press (Power/Standby) (A).

The ventilator runs a self-test and, when complete, displays the Standby window.

Use the ventilator *only* if it passes all tests.

3. Setting up the ventilator

3.10 Enabling sensor monitoring

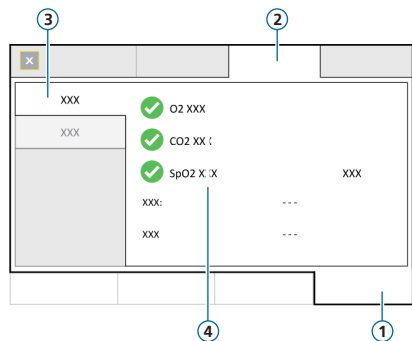

- 1 System
- 2 Sensors
- 3 On/Off
- 4 Sensor options (O2, CO2, SpO2)

To enable sensor monitoring

- 1 Touch **System** > **Sensors** > **On/Off**.
- 2 Select the **O2 sensor***, **CO2 sensor****, and/or **SpO2 sensor**** checkboxes as required, and close the window.

* By default, the O2 sensor is enabled. ** If the option is installed and activated.

4. Configuring patient settings

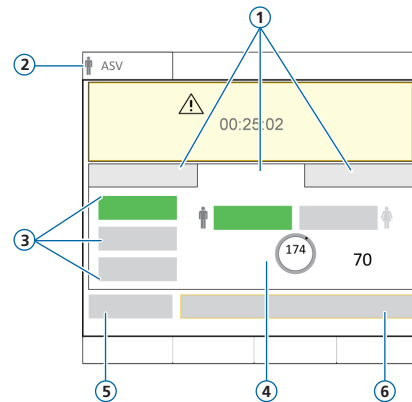

- 1 Patient group: **Neonatal**, **Adult/Ped**, **Last patient**
- 2 Selected mode and patient group
- 3 Quick setups
- 4 Sex, Pat. height, calculated IBW
- 5 Preop check
- 6 Start ventilation

To select the patient group and specify patient data

- 1 Touch **Neonatal**, **Adult/Ped**, or **Last patient** (uses the last-specified settings).
- 2 If **Adult/Ped** is selected, set the patient sex and height. The device calculates the ideal body weight (IBW).
- 3 Touch **Preop check** to perform the preoperational check.

5. Performing the preoperational check

5.1 Leak test

Perform these steps disconnected from the patient.
Prompts are provided in the System > Tests & Calib window.

Step one

- 1 Do either of the following:
 - Touch **System > Tests & Calib**.
 - In the Standby window, touch **Preop check**.
- 2 Touch **Leak test**.
- 3 When prompted, block the patient end of the breathing circuit.
- 4 Hold until instructed to stop on the display.

Pass  or fail  and date/time of the completed test are displayed.

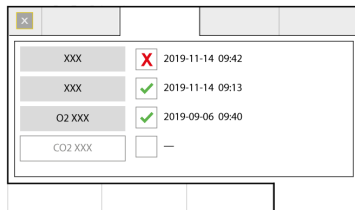



5. Performing the preoperational check

5.2 Calibrating the flow sensor

Step two

- 1 Touch **Flow sensor** to calibrate the flow sensor.
Calibration starts automatically.
- 2 When prompted, attach the calibration adapter to the flow sensor and flip them both 180° so the adapter is directly connected to the limb (as shown below to the right).
Calibration starts automatically.
- 3 When prompted, flip the flow sensor/adapter 180° again, so the flow sensor is directly connected to the limb, and remove the calibration adapter.

Pass  or fail  and date/time of completed test are displayed.

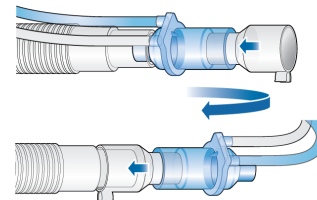
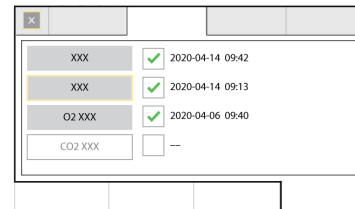

5. Performing the preoperational check

5.3 O2 sensor calibration, alarm tests

Step three

- 1 If an **X** is displayed next to O2 sensor, touch the **O2 sensor** button to calibrate the sensor.
- 2 If the O2 sensor calibration needed alarm is generated, repeat the calibration.

Step four

During ventilator startup, the ventilator performs a self-check that also verifies proper alarm function, including generation of an audible alarm sound.

You are *not* required to perform additional alarm tests.

- ▶ If desired, you can test any adjustable alarm by manually changing the set limit such that the ventilator exceeds or fails to reach this limit, thereby generating the associated alarm.
For details, see your ventilator *Operator's Manual*.

When calibration and tests are complete, the ventilator is ready for use.

5. Performing the preoperational check

5.4 If the preoperational check fails

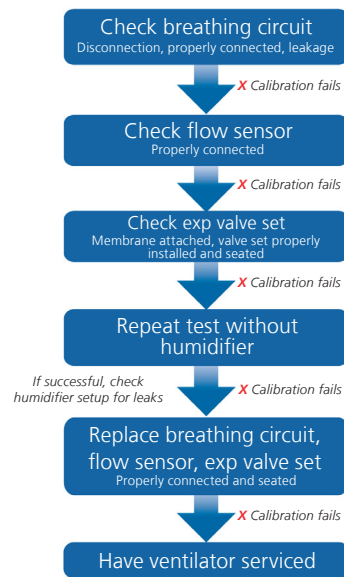

6. Configuring ventilation settings

6.1 Selecting a mode

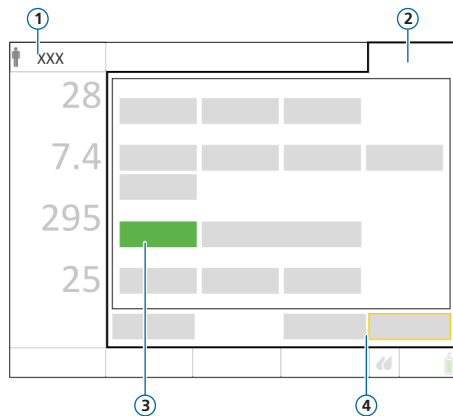

- 1 Active mode and patient group
- 2 Modes button
- 3 New mode
- 4 Confirm/Cancel buttons

To change the mode

- 1 Do either of the following:
 - Touch the mode name (1) at the top left of the display.
 - Touch **Modes** (2) at the top right of the display.

The Modes window opens.

- 2 Touch the desired ventilation mode.
- 3 Touch **Confirm**.
- 4 Review and adjust settings in the Basic and More windows.
- 5 Touch **Confirm***

The mode and settings become active.

* The **Confirm/Cancel** buttons are only displayed when selecting a new mode.

6. Configuring ventilation settings

6.2 Reviewing and adjusting mode controls

Controls window

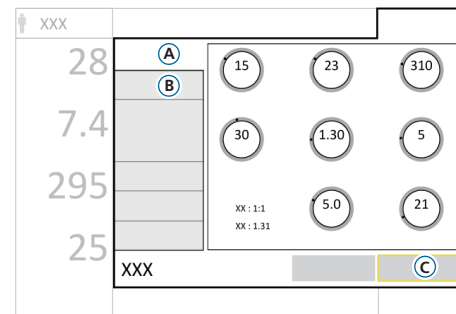

Adjust controls at any time during ventilation.

For details about control settings, see page 44 and your ventilator *Operator's Manual*.

To adjust settings

- 1 Touch **Controls**.
The Controls > Basic (A) window opens.
- 2 Adjust control settings as needed.
- 3 Touch **More** (B) to access additional controls and make changes as needed.
- 4 If displayed*, touch **Confirm** (C). If not, changes are applied immediately.
* Only when changing modes.

To start ventilating the patient

- ▶ Touch **Start ventilation** or press  to start ventilating the patient.

To stop ventilation and enter Standby

- 1 Press .
- 2 In the confirmation window, touch **Activate standby**.

6. Configuring ventilation settings

6.3 Reviewing and adjusting alarm limits

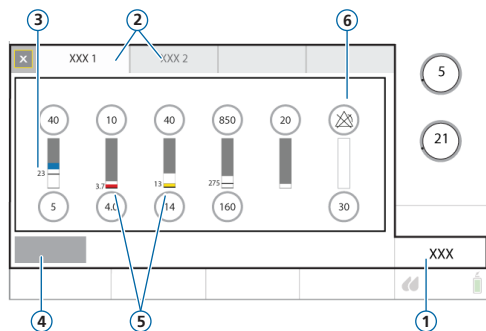

- 1 Alarms
- 2 Limits 1, 2
- 3 Current monitored value
- 4 Auto
- 5 Red or yellow bar (depending on alarm priority) indicates monitored value is out of range
- 6 Alarm off symbol

To review adjustable alarm limits

- 1 Do either of the following:
 - Touch **Alarms**.
 - Touch any MMP.The Alarms > Limits 1 window opens.
- 2 Set alarm limits as appropriate.

Changing the high Pressure and high Vt alarm limits may affect ventilation. See next page.

6. Configuring ventilation settings

6.3 Reviewing and adjusting alarm limits

Maximum pressure during ventilation: High Pressure alarm limit and Plimit control setting

The pressure limit setting, Plimit, defines the maximum allowed pressure to apply during ventilation. It is available in the Controls > Basic window.

The Plimit setting is directly related to the high Pressure alarm limit: changing one of these settings automatically changes the other. The high Pressure alarm limit is always 10 cmH₂O greater than Plimit. An exception is Sigh breaths, when the ventilator may apply inspiratory pressures 3 cmH₂O below the high Pressure alarm limit.

High Pressure alarm limit (1)

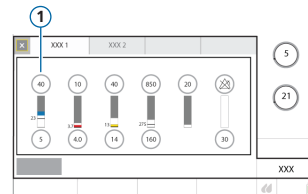

High Pressure alarm limit (1)

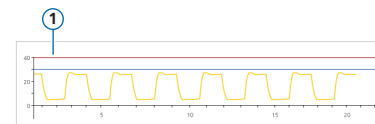

High Vt alarm limit

Inspiratory volume is limited to 150% of the set high Vt alarm limit. Changing the high Vt alarm limit may limit the inspiratory volume. Volume limitation is disabled in noninvasive modes.

7. CPR ventilation

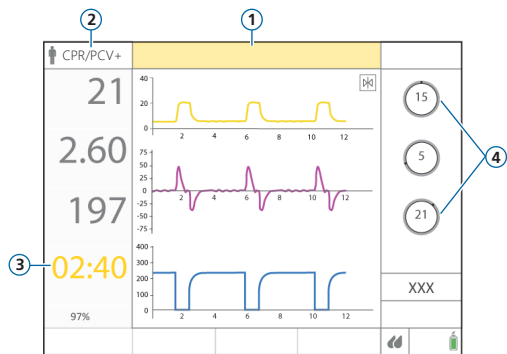

- 1 CPR ON alarm
- 2 Active ventilation mode (APVcmv or PCV+)
- 3 CPR timer
- 4 Mode controls

CPR ventilation allows you to continue providing mechanical ventilation when administering cardio-pulmonary resuscitation.

When activated, CPR ventilation adjusts the ventilator to:

- Use APVcmv or PCV+ mode
- Display relevant MMPs, waveforms, and a CPR duration timer
- Modify alarm limits while CPR ventilation is in use

To start CPR ventilation

- 1 Touch **Modes**.
- 2 In the Modes window, touch **CPR**.
- 3 Review and adjust control settings, then touch **Confirm** to start CPR ventilation.

The mode changes to the configured mode, and the CPR ON alarm is generated. Ventilation starts.

To stop CPR ventilation

- ▶ Enter Standby or change the mode.

8. Monitoring the patient

8.1 Reviewing patient data

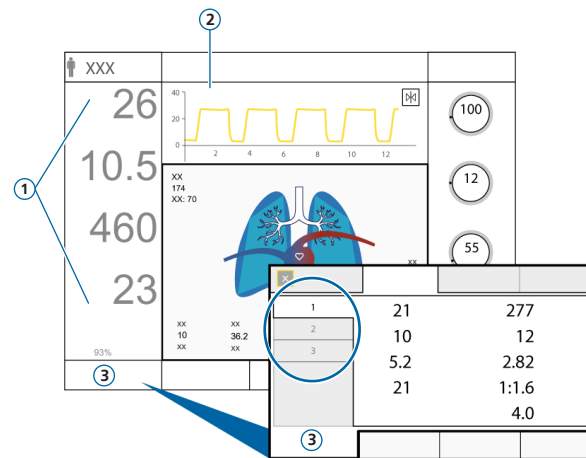

The main display provides an at-a-glance overview of the patient's data.

- 1 Main monitoring parameters (MMP), configurable
- 2 Graphic display, configurable:
 - One or more waveforms
 - Dynamic Lung
 - Vent Status
 - ASV graph (in ASV mode)
 - INTELLiVENT-ASV views (when mode is selected)
 - Trends
 - Loops
- 3 Monitoring window, shows all available monitoring data in three tabbed windows

8. Monitoring the patient

8.2 The Dynamic Lung

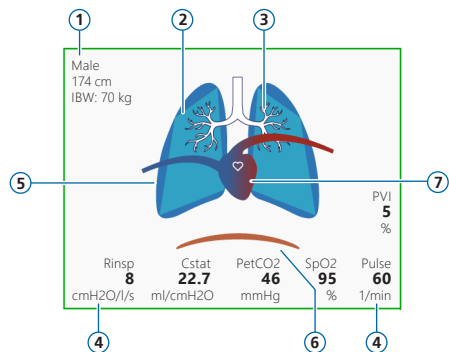

- 1 Sex, height, IBW
- 2 Real-time representation of lung compliance
- 3 Real-time representation of airway resistance
- 4 Parameter values
- 5 Real-time representation of breaths and tidal volume
- 6 Patient trigger (diaphragm)
- 7 Heart and pulse display*

Visualizes in real-time:

- Tidal volume
- Lung compliance
- Resistance
- Patient triggering

The lungs expand and contract in synchrony with patient breaths.

When all values are within the specified ranges, the panel is framed in green.

* When SpO2 is activated and the sensor is connected.

8. Monitoring the patient

8.3 Dynamic Lung: Display of resistance and compliance

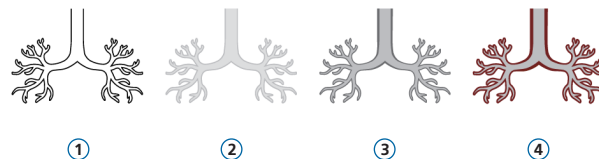

- 1 Resistance information is unavailable
- 2 Normal resistance
- 3 Moderate resistance
- 4 High resistance

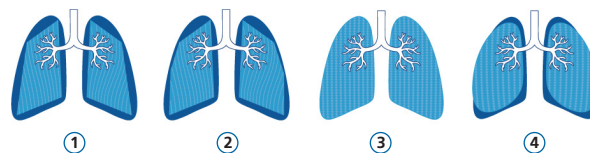

- 1 Very low compliance
- 2 Low compliance
- 3 Normal compliance
- 4 High compliance

8. Monitoring the patient

8.4 Reviewing alarms

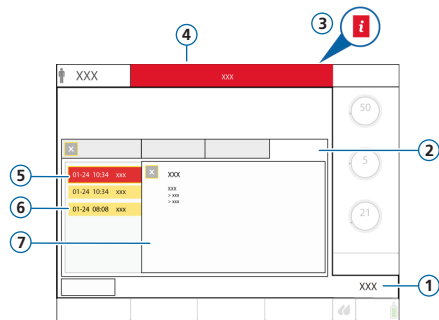

- 1 Alarms
- 2 Buffer
- 3 i-icon (not displayed with active alarms)
- 4 Message bar with alarm
- 5 High-priority alarm (red)
- 6 Medium- or low-priority alarm (yellow)
- 7 On-screen help text

The *alarm buffer* displays *active* alarms. Active alarm messages also alternate in the message bar.

To review active alarms

Do either of the following:

- Touch the message bar.
- Touch **Alarms > Buffer**.

To review previous (inactive) alarms

Do either of the following:

- Touch the i-icon.
- Touch **Alarms > Buffer**.

To view on-screen help text

- ▶ Touch an alarm in the buffer.

A *Help* window (7) opens, displaying the associated help text.

9. Working with a connected HAMILTON-H900 humidifier

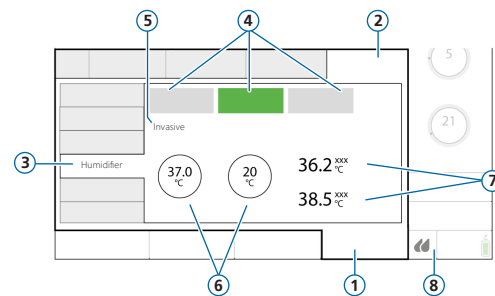

- 1 System
- 2 Settings
- 3 Humidifier
- 4 Off, Auto, Manual (operating mode)
- 5 Active humidification mode (Invasive, NIV, or HiFlowO2)
- 6 Temperature controls: Set temp, T gradient
- 7 Measured temperature: T humidifier, T Y-piece
- 8 Humidifier quick access icon

When the HAMILTON-H900 humidifier is connected to the /COM1 port on the HAMILTON-C1, the ventilator offers remote access to humidifier controls and status directly from the ventilator display.

Functions between the devices are synchronized.

To open the Humidifier window

- ▶ Do either of the following:
 - Touch  (8) on the display.
 - Touch **System > Settings > Humidifier**.

10. Connectivity: Bluetooth, Wi-Fi, Wi-Fi Access Point

Notes

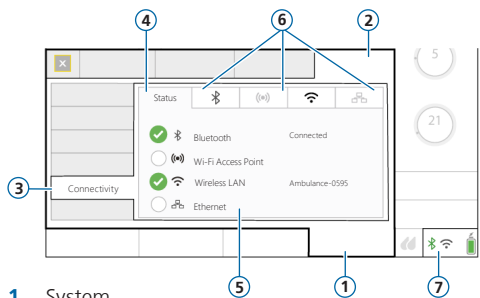

- 1 System
- 2 Settings
- 3 Connectivity
- 4 Status
- 5 Connection types
- 6 Tab for each connection type
Tabs provide relevant info, including PIN, QR code, and profiles, to connect/disconnect using the Hamilton Connect App.
- 7 Connectivity quick access icons

The ventilator can connect to external devices using wired and wireless connection types.

When used with the Hamilton Connect App*, you can connect to a ventilator equipped with the Hamilton Connect Module and view information from the ventilator on your mobile device.

The following connection types are supported:

Bluetooth, Wi-Fi, Wi-Fi Access Point, Ethernet

To open the Connectivity window

Do either of the following:

- Touch an icon in the bottom right of the display, if shown.
- Touch **System > Settings > Connectivity**.

* Available for download on supported iOS and Android mobile devices; see the *Hamilton Connect App Instructions for use*, available on MyHamilton.

11. Ventilation modes

Mode	Description
Volume-targeted modes, adaptive pressure controlled	
APVcmv / (S)CMV+	<i>Adaptive pressure ventilation with controlled mandatory ventilation.</i> Breaths are mandatory, volume targeted, pressure regulated, variable flow, and time cycled.
APVsimv / SIMV+	<i>Adaptive pressure ventilation with synchronized intermittent mandatory ventilation.</i> Volume-targeted mandatory breaths can be alternated with pressure-supported spontaneous breaths.
VS	<i>Volume support.</i> Breaths are flow cycled and deliver a set tidal volume to support patient-initiated breaths.
Pressure-controlled modes	
PCV+	<i>Pressure-controlled ventilation.</i> Breaths are pressure controlled and mandatory.
PSIMV+	<i>Pressure-controlled synchronized intermittent mandatory ventilation.</i> Mandatory breaths are pressure controlled. Mandatory breaths can be alternated with pressure-supported spontaneous breaths.
DuoPAP	<i>Duo positive airway pressure.</i> Mandatory breaths are pressure controlled. Spontaneous breaths can be triggered at both pressure levels. Rate and inspiratory time are set.
APRV	<i>Airway pressure release ventilation.</i> Spontaneous breaths can be continuously triggered. The pressure release between the levels contributes to ventilation. T high and T low settings determine the Rate .
SPONT	<i>Spontaneous mode.</i> Every breath is spontaneous, with or without pressure-supported spontaneous breaths.

Mode	Description
Intelligent ventilation	
ASV	<i>Adaptive support ventilation.</i> Operator sets %MinVol , PEEP , and Oxygen . Frequency, tidal volume, pressure, and I:E ratio are based on physiological input from the patient.
INTELLiVENT-ASV	Ventilator management of CO2 elimination and oxygenation based on clinician-defined target ranges and parameter limits, and physiological input from the patient. The underlying mode is ASV .
Noninvasive modes	
NIV	<i>Noninvasive ventilation.</i> Every breath is spontaneous.
NIV-ST	<i>Spontaneous/timed noninvasive ventilation.</i> Every breath is spontaneous as long as the patient is breathing above the set Rate . A backup Rate can be set for mandatory breaths.
nCPAP	<i>Neonatal only mode.</i> Demand flow Nasal Continuous Positive Airway Pressure.
nCPAP-PC	<i>Neonatal only mode.</i> Breaths are pressure controlled and mandatory.

Additional information is available in your ventilator *Operator's Manual*.

12. Monitoring parameters (ventilator)

Parameter	Description
Pressure	
AutoPEEP	The difference between the set PEEP and the calculated total PEEP within the lungs. AutoPEEP is the abnormal pressure generated by air “trapped” in the alveoli due to inadequate lung emptying. Ideally, it should be zero. AutoPEEP is calculated using the LSF method applied to the entire breath.
Driving pressure (ΔP)	Calculated value showing the ratio of tidal volume to static compliance, which reflects the difference between Pplateau and PEEP.
PEEP/CPAP	Monitored PEEP/CPAP. The airway pressure at the end of exhalation. Measured PEEP/CPAP may differ slightly from the set value, especially in spontaneously breathing patients.
ΔP_{insp}	Inspiratory pressure, the automatically calculated target pressure (additional to PEEP) applied during the inspiratory phase.
Pmean	Mean airway pressure. The absolute pressure, averaged over the breath cycle.
Ppeak	Peak airway pressure. The highest pressure during the previous breath cycle. It is influenced by airway resistance and compliance. Ppeak may differ noticeably from alveolar pressure if airway resistance is high. This value is always displayed.
Pplateau	Plateau or end-inspiratory pressure. The pressure measured at the end of inspiration when flow is at or close to zero. Used as a rough representation of alveolar pressure. Pplateau is displayed for mandatory and time-cycled breaths.
Pprox	The airway pressure at the proximal patient interface. Displayed in HiFlowO2 when a flow sensor is connected.

Parameter	Description
Flow	
Exp Flow	Peak expiratory flow.
Flow (in HiFlowO2)	The flow of gas to the patient in HiFlowO2.
Flow (in nCPAP/ nCPAP-PC)	In nCPAP mode, this value is the average flow, updated every second. In nCPAP-PC mode, this value is the average flow during expiration, updated every breath. Affected by the setting of the Flow alarm. See Chapter 9 of the ventilator <i>Operator's Manual</i> .
Insp Flow	Peak inspiratory flow, spontaneous or mandatory. Measured every breath.
Volume	
ExpMinVol/ MinVol NIV	Expiratory minute volume. The moving average of the monitored expiratory volume per minute over the last 8 breaths. ExpMinVol changes to MinVol NIV in noninvasive modes. MinVol NIV is an adjusted parameter taking leakage into account.
MVSpont/ MVSpont NIV	Spontaneous expiratory minute volume. The moving average of the monitored expiratory volume per minute for spontaneous breaths, over the last 8 mandatory and spontaneous breaths. In noninvasive ventilation modes, MVSpont is replaced by MVSpont NIV. MVSpont NIV is an adjusted parameter taking the leakage into account.
VLeak/ MVLeak	Due to the leakage at the patient interface, displayed exhaled volumes in the noninvasive modes can be substantially smaller than the delivered volumes. The flow sensor measures the delivered volume and the exhaled tidal volume; the ventilator displays the difference as VLeak in %, and as MVLeak in l/min, averaged over the past 8 breaths.
VTE/ VTE NIV	Expiratory tidal volume, the volume exhaled by the patient. If there is a gas leak on the patient side, the displayed VTE may be less than the tidal volume the patient actually receives.

12. Monitoring parameters (ventilator)

Parameter	Description
VTEspont	Spontaneous expiratory tidal volume, the volume exhaled by the patient. Only displayed for spontaneous breaths.
VTI	Inspiratory tidal volume, the volume delivered to the patient, determined from the flow sensor measurement.
Vt/IBW	Tidal volume is calculated according to ideal body weight (IBW) for adult/pediatric patients and according to the actual body weight for neonatal patients.
Time	
fControl	Mandatory breath frequency.
fSpont	Spontaneous breath frequency.
fTotal	Total breathing frequency.
I:E	Inspiratory:expiratory ratio. Ratio of the patient's inspiratory time to expiratory time for every breath cycle. This includes both mandatory and spontaneous breaths. I:E may differ from the set I:E ratio if the patient breathes spontaneously.
TE	Expiratory time. In mandatory breaths, TE is measured from the start of exhalation until the set time has elapsed for the switch to inspiration. In spontaneous breaths, TE is measured from the start of exhalation, as dictated by the ETS setting, until the patient triggers the next inspiration. TE may differ from the set expiratory time if the patient breathes spontaneously.
TI	Inspiratory time. In mandatory breaths, TI is measured from the start of breath delivery until the set time has elapsed for the switch to exhalation. In spontaneous breaths, TI is measured from the patient trigger until the flow falls to the ETS setting for the switch to exhalation. TI may differ from the set inspiratory time if the patient breathes spontaneously.

Parameter	Description
Other calculated and displayed parameters	
CPR Timer	Displayed as an MMP during CPR ventilation, shows how long CPR ventilation has been on.
Cstat	Static compliance of the respiratory system, including lung and chest wall compliances, calculated using the LSF method. Cstat can help diagnose changes in elastic characteristics of the patient's lungs.
Oxygen	Oxygen concentration of the delivered gas.
P.01	Airway occlusion pressure. The pressure drop during the first 100 ms when a breath is triggered. P.01 indicates the patient's respiratory drive and patient inspiration effort. Applies to patient-triggered breaths.
PTP	Inspiratory pressure time product. PTP is valid for patient-initiated breaths only, and indicates work by the patient to trigger the breath.
RCexp	Expiratory time constant. The rate at which the lungs empty.
Rinsp	Resistance to inspiratory flow caused by the endotracheal tube and the patient's airway during inspiration.
RSB	Rapid shallow breathing index. The total breathing frequency (fTotal) divided by the exhaled tidal volume (VTE).
Ventilation time	Displayed in the Controls > Patient window, shows how long the patient has been ventilated.

Information on additional parameters (CO2 and humidifier related) is available in your ventilator *Operator's Manual*.

13. Control settings

Parameter	Description
%MinVol	Percentage of minute volume to be delivered in ASV mode. The ventilator uses the %MinVol, Pat. height, and Sex settings to calculate the target minute ventilation. Add 20% per degree of body temperature > 38.5°C (101.3°F).
Δ Pcontrol	Pressure (additional to PEEP/CPAP) to apply during the inspiratory phase in PCV+ and PSIMV+ modes.
Δ Pinsp	Pressure (additional to PEEP/CPAP) to apply during the inspiratory phase in PSIMV+PSync, and NIV-ST modes.
Δ Psupport	Pressure support for spontaneous breaths in SPONT, NIV, APVsimv, PSIMV+, and DuoPAP modes. It is the pressure (additional to PEEP/CPAP) to apply during the inspiratory phase.
Apnea Backup	A function that provides ventilation after the adjustable apnea time passes without breath attempts.
ETS	Expiratory trigger sensitivity. The percentage of peak inspiratory flow at which the ventilator cycles from inspiration to exhalation.
Flow	In HiFlowO2, Flow is the continuous and constant flow of medical gas to the patient in liters per minute.
Flow trigger	The patient's inspiratory flow that triggers the ventilator to deliver a breath.
HAMILTON-H900 related parameters	Displayed when a HAMILTON-H900 humidifier is connected to the ventilator and the option is installed. For details, see the <i>HAMILTON-H900 Instructions for use</i> .
I:E	Ratio of inspiratory time to expiratory time. Applies to mandatory breaths, and in APVsimv/APVcmv and PCV+ modes.
IBW	Ideal body weight. A calculated value using height and sex, used in calculations for ASV and startup settings for adult and pediatric patients.

Parameter	Description
Oxygen	Oxygen concentration to be delivered.
P high	The high pressure setting in APRV and DuoPAP modes. Absolute pressure, including PEEP.
P low	The low pressure setting in APRV mode.
Pat. height	Patient height. Used together with the sex of the patient to compute ideal body weight (IBW) for adult and pediatric patients.
PEEP/CPAP	Positive end expiratory pressure and continuous positive airway pressure, baseline pressures applied during the expiratory phase.
Plimit	The maximum allowed pressure to apply during ventilation. Changing Plimit or the high Pressure alarm limit automatically changes the other: the high Pressure alarm limit is always 10 cmH2O greater than Plimit. When adjusting pressure controls, the ventilator indicates when the total inspiratory pressure exceeds Plimit. Does <i>not</i> apply in nCPAP or nCPAP-PC modes, with Sigh breaths, or in HiFlowO2.
P-ramp	Pressure ramp. Time required for inspiratory pressure to rise to the set (target) pressure.
Rate	Respiratory frequency or number of breaths per minute.
Sex	Sex of patient. Used together with the patient height to compute ideal body weight (IBW) for adult and pediatric patients.

13. Control settings

Parameter	Description
Sigh	Breaths delivered at a regular interval (every 50 breaths) as follows: <ul style="list-style-type: none">– Pressure-controlled modes: At a pressure up to 10 cmH₂O higher than non-Sigh breaths, as allowed by the upper Pressure alarm setting– Volume-controlled modes: With delivered tidal volume =150% current V_t setting
T high	Length of time at the higher pressure level, P high, in DuoPAP and APRV modes.
T low	Length of time at the lower pressure level, P low, in APRV mode.
TI	Inspiratory time, the time to deliver the required gas for inspiration at the $\Delta P_{control}$ setting. Used with Rate to set the breath cycle time. Applies in PCV+, APVcmv, APVsimv, PSIMV+, and NIV-ST modes.
TI max	Maximum inspiratory time for flow cycled breaths in the following modes: <ul style="list-style-type: none">– NIV and NIV-ST: All patient groups– APVsimv, VS, PSIMV+, DuoPAP, and SPONT: Neonatal patient group
Vt	Tidal volume delivered during inspiration in APVcmv, APVsimv, and VS modes.
Vt/IBW	Tidal volume per weight.
Weight	Actual body weight. Used only with neonates.

Additional information about control settings is available in your ventilator *Operator's Manual*.



Intelligent Ventilation since 1983

Manufacturer:

Hamilton Medical AG

Via Crusch 8, 7402 Bonaduz, Switzerland

☎ +41 (0)58 610 10 20

✉ info@hamilton-medical.com

www.hamilton-medical.com

10086060/01

Specifications are subject to change without notice. Some features are options. Not all features are available in all markets. For all proprietary trademarks (®) and third-party trademarks (®) used by Hamilton Medical AG, see www.hamilton-medical.com/trademarks. © 2020 Hamilton Medical AG. All rights reserved.